



POD DRIVE 3.0 USER MANUAL

Oct, 2019 Version 1.3

Copyright © 2018-2019 ePropulsion. All Rights Reserved

Acknowledgement

Thanks for choosing ePropulsion products, your trust and support in our company are sincerely appreciated. We are dedicated to providing high-performance electric outboards, electric pod drives, sup/kayak motors, reliable lithium batteries and accessories.

Welcome to visit www.epropulsion.com and contact us if you have any concerns.

Using This Manual

Before use of the product, please read this user manual thoroughly to understand the correct and safe operations. By using this product, you hereby agree that you have fully read and understood all contents of this manual. ePropulsion accepts no liability for any damage or injury caused by operations that contradict this manual.

Due to ongoing optimization of our products, ePropulsion reserves the rights of constantly adjusting the contents described in the manual. ePropulsion also reserves the intellectual property rights and industrial property rights including copyrights, patents, logos and designs, etc.

This manual is subject to update without prior notice, please visit our website www.epropulsion.com for the latest version. If you find any discrepancy between your products and this manual, or should you have any doubts concerning the product or the manual, please visit www.epropulsion.com.

ePropulsion reserves the rights of final interpretation of this manual.

This manual is multilingual, in case of any discrepancy in the interpretation of different language versions, the English version shall prevail.

Symbols

The following symbols will help to acquire some key information.



Important instructions or warnings



Useful information or tips

Product Identification

Below picture indicates the serial numbers of Pod Drive 3.0 and NAVY Remote Control. Please note the position of the serial numbers and record them for access to warranty service and other after-sale services.

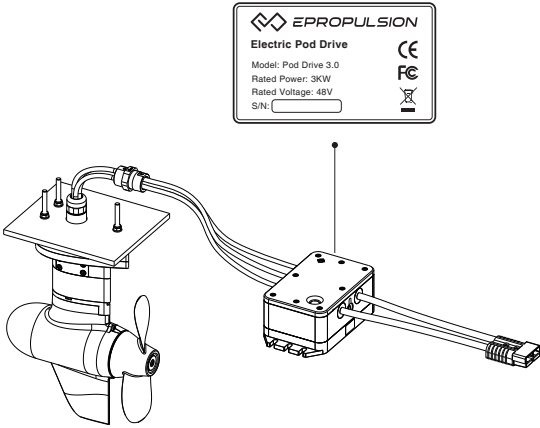

Figure 0-1

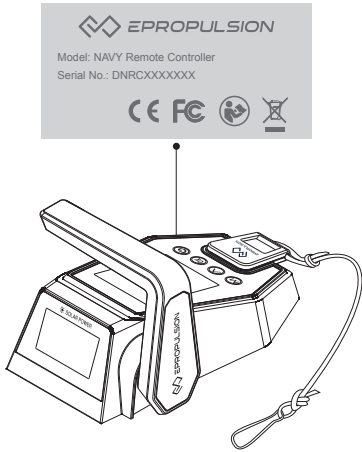

Figure 0-2

 The remote control needs to be purchased separately.

Table of Contents

Acknowledgement	1
Using This Manual	1
Symbols	1
Product Identification	2
1 Product Overview	5
1.1 In the Package	5
1.2 Parts and Diagrams	8
1.3 Technical Data	9
1.4 Important Notes	10
1.5 Declaration of Conformity.....	11
2 Preparations	13
2.1 Selecting the Battery	13
2.2 Checking the Propeller	14
3 Mounting the Motor	15
4 Connecting the Battery	17
4.1 Connecting a 48V Battery	17
4.2 Connecting a NAVY Battery.....	18
4.3 Batteries in Series/Parallel.....	19
5 Remote Control	20
5.1 Displaying.....	20
5.2 Charging	24
5.2.1 Charging by Solar Power.....	24
5.2.2 Charging by Wired Connection.....	24
5.3 Power Adjusting	26
5.3.1 Power Adjusting for Remote Control	26
5.3.2 Recalibration	27
5.4 Use of Kill Switch	28
5.5 Pairing Remote Control with the Pod Drive	28

5.6 Warning Messages	31
6 Configurations.....	34
6.1 Preference Settings.....	34
6.2 Battery Configuration	34
7 Checklist before Use.....	37
8 Starting the Pod	38
9 Stopping the Pod.....	39
10 Transport and Storage.....	40
11 Emergency Situations.....	41
11.1 Collision	41
11.2 Low Battery Level	41
11.3 Over-temperature Protection	41
12 Warranty	42
12.1 Warranty Policies.....	42
12.2 Out of Warranty.....	43
12.3 Warranty Claim Procedures	43



1 Product Overview



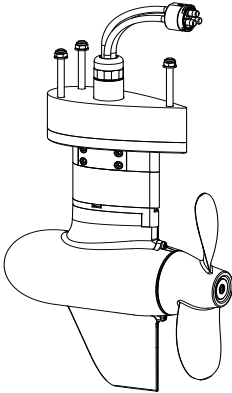
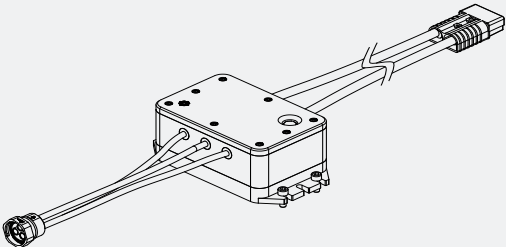

Pod Drive 3.0 is an electric pod drive system of 3kw input power, controlled by either NAVY Remote Control or Side Mount Control. Pod is gaining increasing population among boat owners in recent decades. But available premium electric pod systems are rare. Electric pod drives are environment-friendly, clean and very efficient. This 3kw electric pod drive system is equivalent of 6hp, perfect for recreational small and medium sized boats such as sailboats and some motor boats.

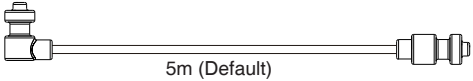
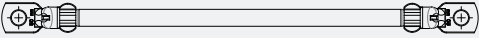
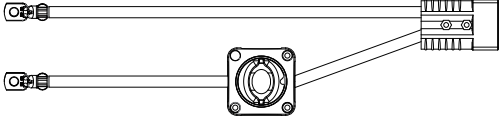
1.1 In the Package

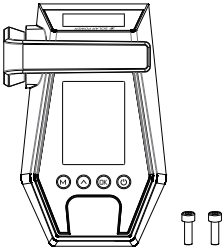
When you receive a set of Pod Drive 3.0, unpack its package and check if all the items below are included in the package. If there is any loss or transport damage, please contact your dealer immediately.

Items	Qty./Unit	Figure
Pod Motor	1 set	
Driver Module (w/ 4 x M8 screws)	1 set	

Items	Qty./Unit	Figure
Communication Cable	1 piece	 <p>5m (Default)</p>
Battery Bridging Cable	3 pieces	
Main Switch Cable	1 piece	
User Manual, Warranty Card, Invitation Card & Quality Certificate	1 set	
Remote Control (Purchased separately)	1 set	

-  The remote control need to be purchased separately.
-  Other accessories such as batteries, charger, etc. appearing in this manual but not included in this package list require users to purchase them from ePropulsion authorized dealers.
-  The propeller is installed on the pod in the package.
-  Save ePropulsion original package for transport and storage.

1.2 Parts and Diagrams

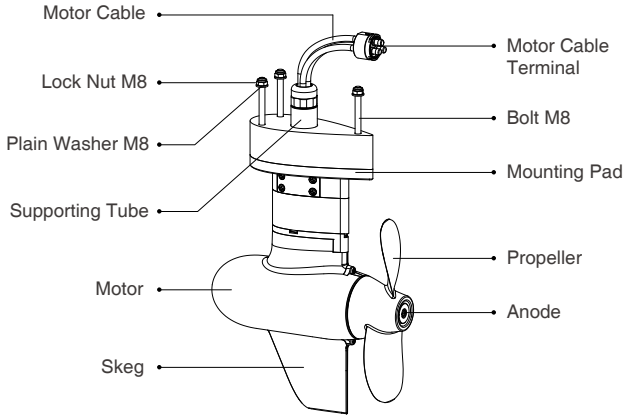

Figure 1-1 Motor Module

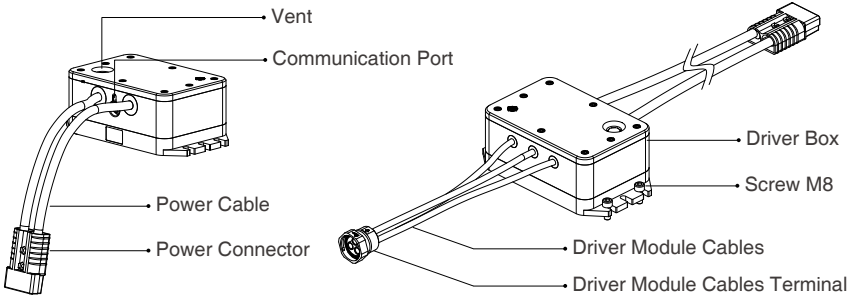

Figure 1-2 Driver Module

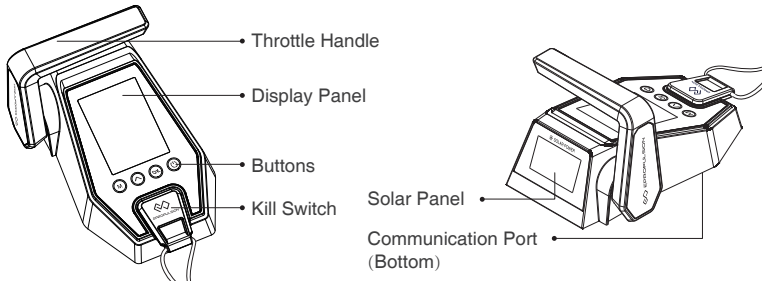

Figure 1-3 Remote Control (Purchased separately)

1.3 Technical Data

Pod Drive 3.0	
Type	Electric
Rated Voltage / Current	48 V / 62.5 A
Applicable Battery	NAVY Battery, 48V battery or 4 x 12V battery (in serial connection)
Input Voltage Range	39 V ~ 60 V DC
Maximum Input Power (Forward / Reverse)	3 kW / 3 kW
Comparable Petrol Outboard	6 HP
Motor	Brushless DC Motor
Maximum Overall Efficiency	51%
Rated Rotation Speed (Forward)	2300 rpm
Control System	Remote / Side Mount Control
Remote Communication	Wireless / Wired
Wireless Communication Distance	≤10m
Side Mount Control Communication	Wired
Pod Drive Weight (Set)	12 kg
Propeller (Diameter / Pitch)	260mm (10.2") / 6.73"
Operating Temperature	-25°C ~ 50°C (-13°F ~ 122°F)

1.4 Important Notes

1. When choosing wireless remote control, ensure the top of pod driver module is uncovered to avoid GPS signal attenuation.
2. Only adults who have fully read and understood this manual are allowed to operate this product. Read the full user manual carefully before operation, ePropulsion accepts no liability for any damage or malfunction caused by operations violating this manual.
3. Only boat owners who are familiar with their boats are allowed to use this pod system. For a newly bought boat, the boat owner should learn all aspects of the boat including how the boat behaves at different conditions and practicing controlling the boat before mounting and operating this pod system.
4. Before operation, familiarize yourself with all the functions and operations of this product. If there are more than one person onboard, make sure you are not the only one onboard who knows how to operate this pod drive system to help in case of an unforeseen emergency.
5. Follow boat builder's instructions to mount this product to your boat. It is suggested to have certified boat builders or professional installers to install this pod system to your boat. Never try to install the pod system on your own if you never have experience of mounting a pod to your boat before.
6. Check the weather before operation.
7. Watch the environment before operation. The rotating blades of pod drives is very dangerous and will hurt people or creatures. Do not operate the pod drive in areas with swimmers or bathers around.
8. If the pod drive system is the only power source of your boat, make sure batteries on board have enough power for your round trip. We recommend you to calculate distance and battery consumption.
9. Check before each trip if there are enough safety equipment including but not limited to enough life jackets, personal flotation devices, fire extinguishers, bells and whistles, communication equipment, and paddles, etc. Check available local boating safety requirement before operating.
10. If the pod drive strikes other objects in water, please stop running and turn off the main switch immediately. Return to the nearest harbor and find your dealer for assistance.

1.5 Declaration of Conformity

Object of the declaration:

Product: Electric Outboard Motor

Model: Pod Drive 3.0

Company Name: Dongguan ePropulsion Intelligence Technology Limited

Company Address: Room 202, Bldg.17A, Headquarter No.1, 4th XinZhu Road, SongShan Lake District, Dong Guan, Guang Dong, China

The object of the declaration is in conformity with the following directives:

EMC-directive	2014/30/EU
MD-directive	2006/42/EC
RED Directive	2014/53/EU

Applied standards:

EN 55014-1:2006+A1:2006+A2:2011

EN 55014-2:2015

EN 61000-3-2:2014

EN 61000-3-3:2013

EN 60204-1: 2016

EN ISO 12100:2010

EN 301 489-3: 2002 V1.4.1

EN 301 489-1:2008 V1.8.1

CE Test Report NO.: ATT1709040251D, ATT1709040251E, ATT1709040251M

Issued Date: September 30, 2017

The original certificates were issued by:

Shenzhen An-Teng Testing Service Co., Ltd. in Shenzhen, China.

This device complies with part 15 of the FCC Rules: Operation is subject to the following two conditions:

- (1) This device may not cause harmful interference and,
- (2) This device must accept any interference received, including interference that may cause undesired operation.

FCC Test Report NO.: GTS201709000032E01

Issued Date: July 05, 2017

FCC Statement

This equipment has been tested and found to comply with the limits for a Class B digital device, pursuant to Part 15 of the FCC Rules. These limits are designed to provide reasonable protection against harmful interference in a residential installation. This equipment generates uses and can radiate radio frequency energy and, if not installed and used in accordance with the instructions, may cause harmful interference to radio communications. However, there is no guarantee that interference will not occur in a particular installation. If this equipment does cause harmful interference to radio or television reception, which can be determined by turning the equipment off and on, the user is encouraged to try to correct the interference by one or more of the following measures:

- Reorient or relocate the receiving antenna.
- Increase the separation between the equipment and receiver.
- Connect the equipment into an outlet on a circuit different from that to which the receiver is connected.
- Consult the dealer or an experienced radio/TV technician for help.

The manufacturer is not responsible for any radio or TV interference caused by unauthorized modifications to this equipment. Such modifications could void the user's authority to operate the equipment.

Signed by : 陶师正

Shizheng Tao, Chief Executive Officer & Cofounder of
Guangdong ePropulsion Technology Limited

2 Preparations

2.1 Selecting the Battery

Lithium-based and lead-acid batteries can be used to supply power for Pod Drive 3.0. Considering the high performance in energy density and discharge ability, lithium-based batteries are more preferable. To ensure that Pod Drive 3.0 can work at its full power continually, the batteries are required to possess over 62.5A of continuous discharge current. To ensure longer operating duration, the battery capacity is recommended to be 3000Wh or above.

The rated continuous discharge current is affected by the battery type and quantity of parallel batteries. To use lead-acid batteries, conventional lead-acid or AGM or GEL batteries are acceptable, while starter batteries are not recommended. Traction batteries or deep cycle batteries are more preferable as they give power over sustained period of time. Besides, the deep cycle marine batteries are also capable.

Battery capacity is a major factor that affects trip duration and distance. For instance, a battery with 48V of rated voltage completely discharges at a continuous current of 62.5A in 1 hour, so its rated capacity is 3000Wh ($62.5\text{Ah} \times 48\text{V} = 3000\text{Wh}$), we also can say its rated capacity is 62.5Ah. The maximum power of Pod Drive 3.0 is 3KW which means the system can be running at full power for about 1 hour when using this battery. You can select a battery with proper capacity based on your requirements for travelling time and distance. Note that the operating time and distance are also affected by the input power of the motor plus the external environment and temperature. In addition, the type and tonnage of boats also play important roles.

Users can choose NAVY Battery. It is a lithium-ion battery with 3000Wh capacity specially designed for NAVY series motors. When using with Pod Drive 3.0, one or more sets of NAVY Batteries are required. When more than one NAVY Batteries are used in parallel, communication cables should be used to connect NAVY Batteries and Pod Drive 3.0 for internal information exchange.

Users can also connect four 12V batteries in tandem to make a 48V battery set and use it to supply power for Pod Drive 3.0. Users can also enlarge the battery capacity by parallel configuration.

⚠ When using with NAVY Batteries, the batteries will work properly when correctly connected. When using non-ePropulsion batteries, before starting the pod drive, users should configure the batteries via the Remote Control for the first time use, otherwise the batteries may not work properly.

⚠ Only use the same batteries (same model, same capacity, same age and same manufacturer) in series or in parallel configuration. Variations in the batteries will cause damage to them.

2.2 Checking the Propeller

The propeller is assembled on the pod. Before use, check the propeller and if necessary, e.g. the original propeller is broken, change a new propeller. Follow instructions in Figure 2-1 to assemble a propeller properly.

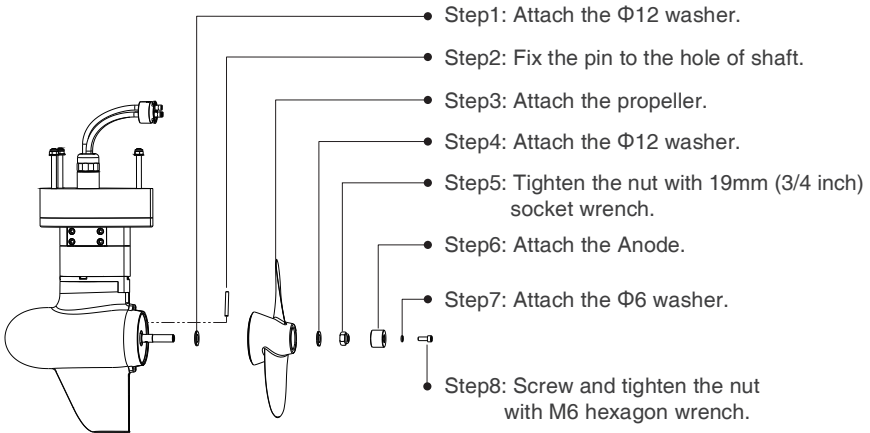

Figure 2-1

3 Mounting the Motor

⚠ It is suggested to have certified boat builders or professional installers to install this pod system to your boat. Follow boat builder's instructions strictly to mount this product to your boat. Never try to install the pod system on your own if you are not experienced at that.

Step 1: Drill four holes in the proper position through the hull bottom. The suggested dimensions of the four holes are shown below:

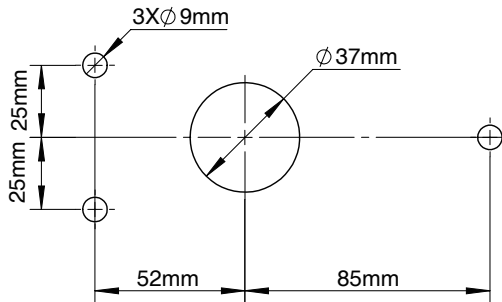

Figure 3-1

Step 2: Hold the pod motor and insert its two M8 bolts and supporting tube into the holes from below the hull bottom. Then lock the each M8 bolt from inside the boat by a plain washer and a nut (Figure 3-2).

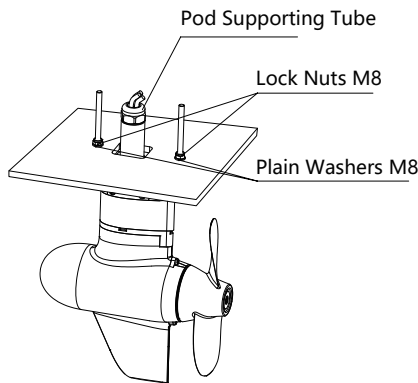

Figure 3-2

Step 3: Connect the motor cables terminal with the driver module cables terminal. Align the arrows ① in the terminals first (refer to Figure 3-3) then plug in. After two terminals are properly connected, lock them by the buckle ring in the direction of arrow ② .

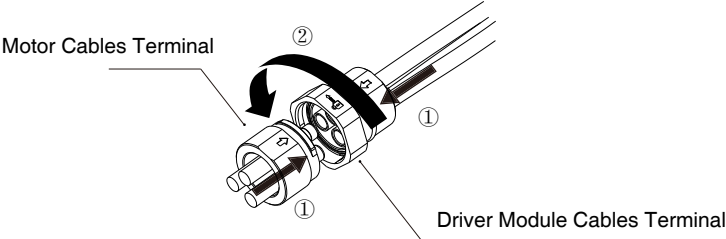

Figure 3-3

! Align the two terminals before coupling the two parts. Fail to do so can cause motor reversion.

Step 4: Place the driver module in an appropriate place on board and fix it with four M8 screws.

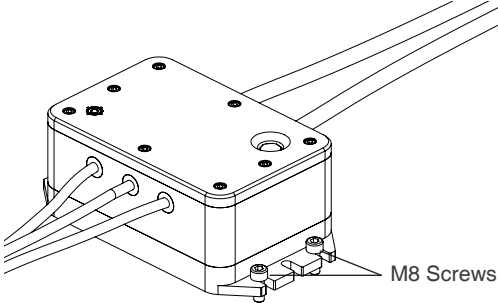

Figure 3-4

4 Connecting the Battery

4.1 Connecting a 48V Battery

⚠ Before connecting to a battery, make sure the main switch is off.

⚠ Avoid short-circuit while connecting batteries.

- ① Connect the main switch cables to the battery.
- ② Connect the main switch cables with the input cables of Driver Module.

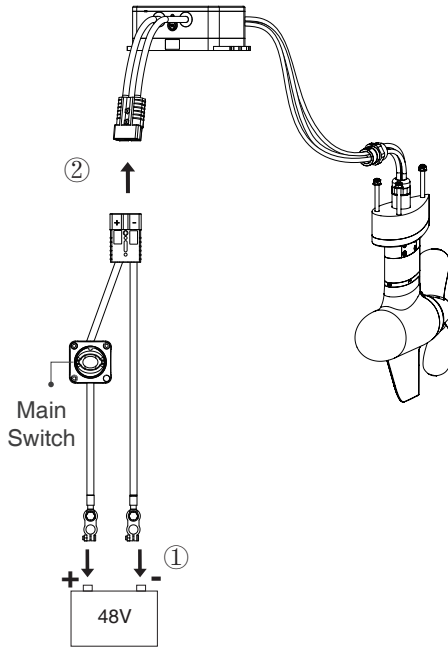

Figure 4-1

💡 For non-NAVY batteries, please configure them by Remote Control for the first time use, otherwise the batteries may not work properly.

💡 The motor will stop if the power cable disconnects.

💡 Rotate the main switch clockwise to power on the battery before use.

💡 The main switch and power cable are connected by screws that may loosen after long-time use. Loosen screws will lead to poor contact. If this problem happens, open the back cover of the main switch, and tighten the screws inside.

4.2 Connecting a NAVY Battery

⚠ Before connecting, make sure the main switch is off.

⚠ Avoid short-circuit while connecting batteries.

① Connect the main switch cables to NAVY Battery.

② Connect the main switch cables to Driver Module.

③ Connect NAVY Battery and Driver Module by a communication cable.

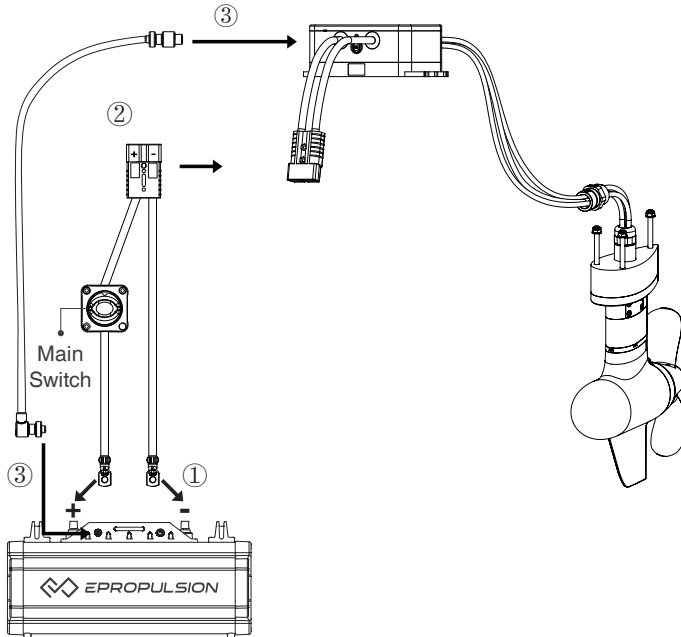

Figure 4-2

⚠ The pod will stop if the communication cable or power cable disconnects.

⚠ Use communication cables to connect NAVY Batteries when multiple NAVY Batteries are used in parallel.

💡 Rotate the main switch clockwise to power on the battery before use.

💡 The main switch and the power cable are connected by the fixing screws that may loosen after long-time use. Loosen screws will lead to poor contact. If this problem is discovered, open the back cover of the switch, and then tighten the screws inside.

4.3 Batteries in Series/Parallel

Users can also choose to make a 48V battery by connecting four 12V batteries in series. When connecting four 12V batteries in series to make a 48V battery set to supply power for Pod Drive 3.0, use bridging cables to connect batteries in series (Figure 4-3). Make sure to connect the cable with main switch attached to the positive terminal and connect the other cable to the negative terminal.

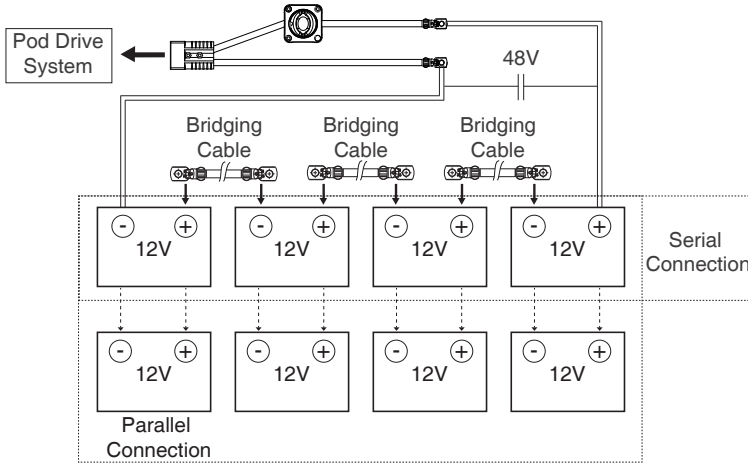





Figure 4-3

-  Only use the same batteries (same model, same capacity, same age and same manufacturer) in series and/or in parallel. Variations in batteries will cause damage.
-  Never reverse the polarity. Please pay more attention when connecting batteries in series and/or in parallel configuration. Always double check by referring to Figure 4-3.
-  NAVY Batteries support parallel connection. Up to 8 NAVY Batteries can be connected in parallel.

5 Remote Control

NAVY Remote Control is used to start and stop the motor, adjust speed, configure battery parameters and display system information, etc.

5.1 Displaying

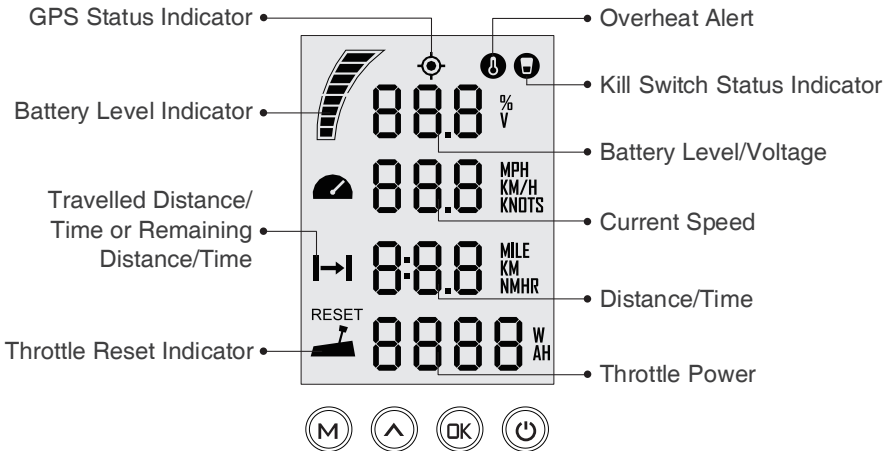

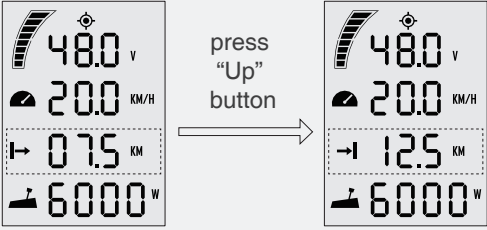
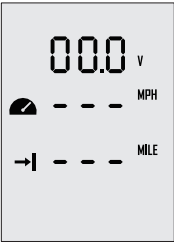

Figure 5-1

Buttons	Functions
 "Power"	<ol style="list-style-type: none"> In power-off state, press and hold the power button to power on the remote control. In power-on state, press and hold the power button to power off the remote control.

Buttons	Functions
<p>OK "OK"</p>	<ol style="list-style-type: none"> 1. On setting pages, press " OK " button to save the current settings and switch to the next item. 2. On setting pages, press and hold " OK " button, and the system will save your settings, the display will exit from setting page and return to the home page. 3. If home page displays or all characters display on the page, press " OK " button and hold 5s to enter the pairing page.
<p>^ "Up"</p>	<ol style="list-style-type: none"> 1. On any setting page, press "^" button to view options for current setting. 2. In power-on state, when home page displays, press "^" button and hold 10s to enter the throttle calibration page. 3. On home page, press "^" button to switch the travelling distance or time displaying icon between "→ " and "┆ ". <div style="text-align: center;">  <p>Main page 1 Main page 2</p> </div>
<p>M "Menu"</p>	<ol style="list-style-type: none"> 1. In power-on state, press and hold "M" button to enter the preference setting page. <div style="text-align: center;">  <p>Preference setting page</p> </div>

2. On preference setting page, press and hold “M” button to enter the battery setting page.





















Battery setting page

3. On any page, press “M” button to return home page.

 If users enter the page without setting any parameters, the current parameters displayed on the page will be saved as user parameters by default.

 If “545
in if” shows on start-up, it indicates system initialization.

Icons	Functions	
	Battery level indicator	Indicating approximate battery level. The solid blocks stand for remaining battery.
	Battery level/voltage	Indicating accurate current battery level percentage/battery voltage, is configurable in preference setting page. For example: 100%: indicates current battery level. 48.0 v: indicates current battery voltage.
	GPS status indicator	<ul style="list-style-type: none">  Hidden: no satellite signal is received or GPS does not work.  Blink: GPS is connecting to satellites.  Shown constantly: GPS is in use.

Icons	Functions	
	Over-heat alert	<ul style="list-style-type: none">  Hidden: system temperature is in normal range.  Blink: system temperature is a little high and the maximum input power of motor has been lowered than 3KW.  Shown constantly: system is over temperature and the pod will stop working. The pod can't be started until the system temperature drops to a certain level.
	Kill switch status indicator	<ul style="list-style-type: none">  Hidden: kill switch is present and is working well.  Shown constantly: the kill switch is detached.
 88.8 MPH KM/H KNOTS	Current speed	<p>Displaying real time cruising speed. Set units (KM/H,MPH or KNOTS) in preference setting page.</p>
8:8.8 MILE KM NMHR	Distance/time display	<p>Displaying real time travel distance/time. Set units (MILE, KM (kilometer) and NM (nautical mile)) in preference setting page. The time unit is HR (hour).</p>
	Travelled distance/time or remaining distance/time	<p>: Remaining distance or time that the pod system can travel. Set units (MILE, KM (kilometer) and NM (nautical mile)) in preference setting page.</p> <p>: Travelled distance or time.</p>
 8888	Throttle Power	<p>Displaying real time input power to the system. A blinking “RESET” indicating the throttle should be reset to zero position.</p>

5.2 Charging

The remote control has an in-built lithium battery for power supply. The battery will be charged automatically under normal use: get charged by solar power or wired connection.

5.2.1 Charging by Solar Power

When the solar panel receives enough sunshine, it will generate electricity to charge the in-built lithium battery.

 Face the solar panel of the remote control toward sunlight to get better charging effect.

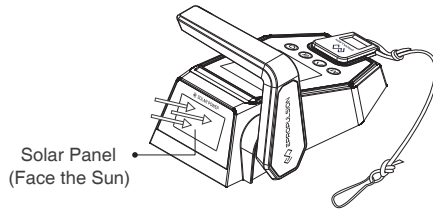



Figure 5-2

 Charging by solar power is recommended.

5.2.2 Charging by Wired Connection

If the remote control can't get enough solar power for a long time, the battery will run out. In this case, error code E60 (Figure 5-3) will display to remind you to charge the remote control.



Figure 5-3

In this case, charging by wired connection is faster.

Use a communication cable to connect the remote control and the driver module. Then make sure the system battery is well connected to the driver module and powered on.

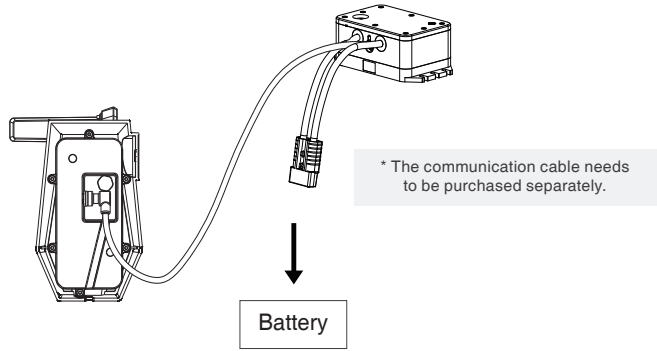





Figure 5-4

-  During long-term storage, ensure to charge the remote control every 6 months to avoid over-discharge.
-  After long-term storage, charge the remote control before use.
-  The communication cable is not included in this package. Please purchase one from your dealer if you choose this charging method.
-  Once the communication cable disconnects, charging automatically stops and the running motor stops. Please restart the motor.

5.3 Power Adjusting

5.3.1 Power Adjusting for Remote Control

The Remote Control is mainly used to adjust the input power of the motor. When the battery is well connected and switched on, power on the Remote Control to start the pod drive, then slowly push the throttle forward position to increase the power. The maximum forward/backward power is 3KW.

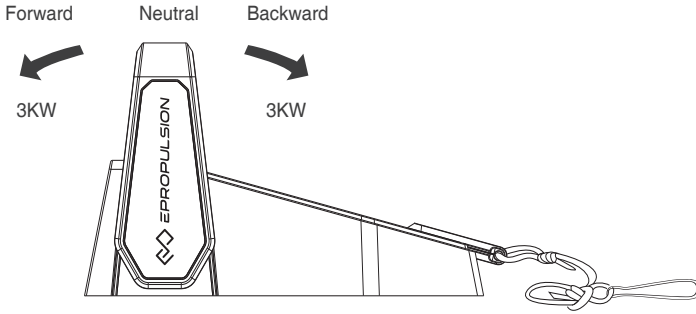







Figure 5-5

- 💡 Before power on the Remote Control, please reset the throttle to neutral position.
- 💡 If you find a blinking “**RESET**” on the display panel, you are reminded to reset the throttle to neutral position.
- 💡 If you pull the throttle from the forward position to the backward position directly, the motor will first stop shortly, then start turning to the reverse direction.

5.3.2 Recalibration

Throttle position sensor should be recalibrated if error code E30 displays.

 Users should calibrate the throttle **strictly** as below steps.

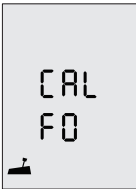
Recalibration process	LCD Displaying
<p>Step1: Long press “^” button for 10s until “CAL FO” displays.</p>	
<p>Step2: Push the throttle to the maximum forward power position, then press “^” button. “CAL ST” will display and “CAL” will be blinking.</p>	
<p>Step3: Pull the throttle to the middle (zero) position where you can hear a click sound, then press “^” button, “CAL bA” will display and “CAL” will be blinking.</p>	
<p>Step4: Pull the throttle to the maximum backward power position, then press “^” button. “CAL FO” will display and calibration is completed. A blinking “RESET” will display to remind you to reset the throttle to zero position.</p>	
<p>Step5: Push the throttle to zero position and press the “M” button and return to the main page.</p>	

5.4 Use of Kill Switch

- Attach the kill switch and tie its lanyard to your wrist or life jacket.
- Stop the pod drive in emergency by detaching the kill switch.
- To run the motor again, first attach the kill switch then start the motor.

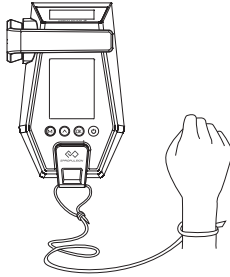

Figure 5-6

- ⚠ The kill switch generates magnetic field. Keep it 50cm / 20inches away from medical implants like pacemakers and magnetic cards (e.g. credit card) as well as other magnetic media.
- ⚠ The magnetic field of the kill switch may interfere with some electronic instruments. Keep it away from these electronic instruments.

5.5 Pairing Remote Control with the Pod Drive

Before use please pair remote control with the pod drive. There are two methods to pair the remote control. Please choose one of the two methods and follow the steps to build new communication.

Method 1. Automatic Pairing without Communication Cable

Step1: Switch off system power and hold the remote control within 0.5m of the driver module.

Step2: Press and hold the “” button to switch on the remote control.

Step3: Press “**OK**” button and hold **5s** to enter the pairing setting page (Figure 5-7). On this page, you can find the blinking “**ADD**” (address) and “**SET**” (set), and a countdown timer “**060**” (60s).



Figure 5-7

Step4: Switch on system power. Wait the remote to get paired in seconds.

Step5: After pairing, the LCD panel will display as Figure 5-8 for 5s, then returning to home page automatically.



Figure 5-8

 If pairing fails within 60s, go back to **Step3** and try again.



Method 2. Automatic Pairing with Communication Cable

Step1: Switch off system power and the remote control.

Step2: Connect the remote control and the driver module with a communication cable.

Step3: Switch on system power and the remote control. Wait for them to get paired in seconds. Pairing succeeds when home page displays.

Step4: Disconnect the communication cable.

 If “” shows on start-up, it indicates system initialization.

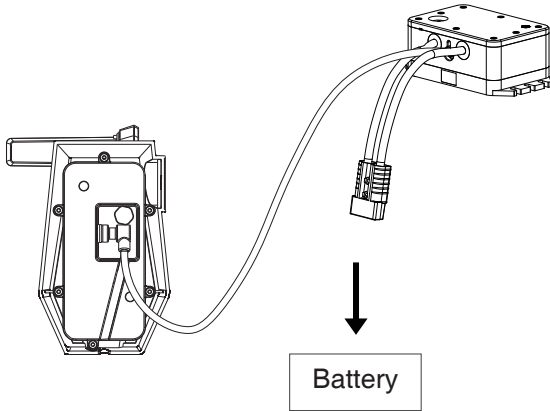

Figure 5-9

If the wireless link breaks (this case often happens when the remote control or the driver module is replaced with a new one), the remote panel will display as below and users need to build new communication between the new pair before use.

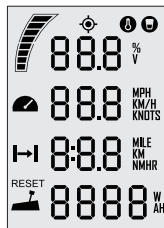



Figure 5-10

 However, if all parts have not been replaced, but the remote control still indicates communication failure, you should check to make sure if:

- 1) the remote control is out of communication range;
- 2) the system is normally powered on.

If the remote control still displays communication error after check. Please contact your dealer for repair.

5.6 Warning Messages

When the pod drive motor is running in abnormal conditions or out of order, a warning message with an error code will display on the LCD panel. Figure 5-11 is an example. Please find more error codes and corresponding solutions in the below table.



Figure 5-11

Code	Cause	Solution
E01	Battery voltage beyond operation range.	Replace a battery based on suggested operation specifications.
E02	Propeller may be blocked, causing motor overcurrent	Refer to Solution to E10.
	Motor fails or circuit board fails causing motor overcurrent	Try to turn off the main switch and wait for 10 seconds then turn on the switch again.
E06	The battery voltage level is too low.	Operate the motor at low power. Please charge the battery as soon as possible.
E10	Motor stall, which may be caused by blocked propeller	Turn off power, then clean up the things winding around the propeller. Test if the propeller can be rotated by hand before operation.
E11	The temperature of motor is too high.	Stop operating the pod drive and wait until the temperature falls within the normal operating temperature range.

Code	Cause	Solution
E12	The temperature of circuit board is too high.	Stop operating the pod drive and wait until the temperature falls within the normal operating temperature range.
E15	Failure was found in the circuit board temperature sensors.	Try to turn off the main switch and wait for 10 seconds then turn on the switch again.
E16	Calibration Abnormality of Current Sensor	Please contact the dealer for help.
E22	MCU Communication Abnormality	Please restart to see if the error disappears, if not, please contact your dealer for help.
E25	The remote is not paired to the pod driver	Pair the remote to the pod driver module.
E30	Throttle position sensor failure, should recalibrate the throttle position sensor.	Please refer to section 5.3.2 <i>Recalibration</i> to recalibrate the throttle position sensor.
E40	System running failure	Please restart the remote control and the pod drive system.
E55	Battery is running out of power	Charge the battery.
E56	Communication Error between pod drive and NAVY battery	Check if the communication cable between pod drive and NAVY battery is well connected, if yes, please restart the system.

Code	Cause	Solution
E57	NAVY battery overcurrent	<ol style="list-style-type: none"> 1. Ensure the paralleled NAVY batteries have similar voltage with pressure difference within 2V. 2. Ensure the power cable and battery are firmly connected to avoid poor contact. 3. Restart the battery when the error occurs and keep the parallel state for 30 minutes to wait for the batteries to self-balance the voltage. 4. If the error occurs, users can also continue operating after restarting the battery, but do not operate at full power state. The operating power is suggested to be lower than two thirds of full power. Please fully charge the battery after use.
E60	The remote control is running out of power.	Please connect the remote control to the pod by a communication cable. Please refer to section 5.2.2 <i>Charged by Wired Connection</i> .
All characters display	The motor has no power.	Connect the battery to the pod drive and then turn on the main switch.
	Device addresses mismatch.	Please refer to section 5.5 <i>Pairing Remote Control with the Pod Drive</i> .

 If the problem persists, please consult your ePropulsion authorized dealer for assistance.

6 Configurations

6.1 Preference Settings

It's advised to set display preference by these steps before operation.

Step1: In power-on state, press “**M**” button and hold to enter the preference setting page as shown in Figure 6-1. Users can choose display items based on personal needs and preference.



Figure 6-1

Step2: On the preference setting page, the blinking item is the item waiting to be set. Press the “**▲**” button to view options for the blinking item. For example, in Figure 6-1, if “**V**” is blinking on the preference setting page, it means that “**V**” has other alternate options. Just press the “**▲**” button, and “**V**” will switch to “**%**”, i.e. the displayed item is switched from voltage to battery level.



Step3: Press “**OK**” button to save setting for the current item and skip to the next item simultaneously.

Step4: When all the items have been set well, long press the “**OK**” button to save all the settings and return to the main page.

6.2 Battery Configuration

Accurate battery configuration helps achieve precise estimation of the battery's discharging state. When using an ePropulsion NAVY Battery (standard), battery configuration is self-activated by the control system given that all the communication cables are well connected. When not using NAVY Batteries, users should manually configure the batteries via remote control at the first time use, otherwise the batteries may not work properly.

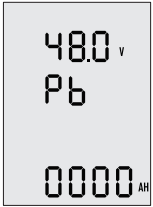
⚠ Battery configuration should be carried out if a battery with different type/capacity/voltage is connected to the pod drive for the first time.

Battery Configuration Process	LCD Displaying
<p>Step1: First, turn on the main switch and the remote control.</p> <p>Then, press “M” button and hold to enter the preference setting page.</p> <p>Next, press “M” button and hold again to enter the battery setting page. Users can see the voltage value blinking and it’s ready for configuration.</p>	
<p>Step2: Press “OK” button and skip to the next item: battery type.</p> <p>Choose the battery type according to the battery you use.</p> <p>Pressing “^” button to switch the battery type options between Pb, Li and LFE.</p> <p>Pb: Lead-acid battery Li: Lithium battery LFE: Lithium-ion ferrous phosphate battery</p>	
<p>Step3: Press “OK” button to save battery type and skip to the below battery capacity setting item.</p> <p>Press “^” button to change the value and set the battery capacity according to the battery you use.</p> <p>Note that the unit of capacity is “Ah”, usually the capacity of battery is expressed in “Wh”, and we can get the capacity in “Ah” by following the below formula:</p> $\text{Capacity in Ah} = \frac{\text{Capacity in Wh}}{\text{Nominal voltage in V}}$ <p>E.g. if users use a 3000Wh Lithium battery with 48.1V nominal voltage, then the battery is about 62.37Ah, so you can set 62Ah as the capacity setting.</p>	

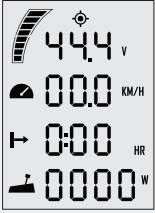
Battery Configuration Process	LCD Displaying
<p>Step4: Press “ OK ” button to save battery capacity setting, and it will return to the top battery nominal voltage setting item.</p> <p>The voltage options are varied according to the battery types. Press “ ^ ” button to view the options and select the closest nominal voltage value according to the battery you use.</p>	
<p>Step5: Press and hold “ OK ” button to save all the settings and return to the main page.</p>	

 Lithium batteries, lead acid batteries and lithium iron phosphate batteries are recommended to use with Pod Drive 3.0. Other types of battery may fail to make the pod drive work properly.

 When you use the below batteries, please set battery type and rated voltage value based on the parameters in the following table.

Battery type	Nominal Voltage options										
LI	43.2V	44.4V	45.6V	46.8V	48.1V	49.4V	50.4V	51.8V	53.2V		
Pb	44.0V	46.0V	48.0V	50.0V	52.0V	54.0V					
LFE	44.8V	48.0V	51.2V								

 Update the battery configuration is necessary if a different type of battery has been applied.

 When using non-ePropulsion batteries, before starting the pod, users should configure the batteries via the remote control for the first time use, otherwise the batteries may not work properly.

7 Checklist before Use

1. Ensure the propeller is correctly and firmly mounted on the pod drive.
 2. Ensure the pod drive is correctly and firmly mounted on the boat.
 3. Ensure the remote control and steering wheel are installed in proper position before turning on the power.
 4. Ensure the throttle travels smoothly with no obstacles.
 5. Before connecting the battery, check and make sure there is no poor contacts or defects in cables.
 6. Check and ensure the main switch is able to power on and off normally.
After that, turn off the main switch.
 7. Ensure the battery has enough power.
 8. Ensure the remote control has enough power.
-  Make sure the power cable is dry before connecting it to the battery or powering on the system.

8 Starting the Pod

1. Complete the check list.
2. Remove the kill switch from the remote control.
3. Push the throttle to zero position.
4. Connect the battery with the driver module.
5. Turn on the main switch. When using with NAVY Batteries, please also turn on the batteries by pressing the power button.
6. Press “  ” button to turn on the remote control.
7. Carry out preference setting and battery configuration if necessary.
8. Tie the kill switch to your wrist or life vest, then attach the kill switch on the remote control.
9. Push the throttle slowly to start running.

9 Stopping the Pod

It's recommended to stop the pod as the following procedures.

1. Return the throttle to zero position.
2. Wait until the motor stops, then detach the kill switch.
3. Press and hold the “ ⏻ ” button until the remote control is switched off.
4. Turn off the main switch. If the pod is connected to a NAVY battery, please also turn off the battery by pressing the power button.



The motor will also stop in any below situations.

- 1) Throttle is in zero position.
- 2) Kill switch is not placed in the correct position.
- 3) Main switch is turned off.
- 4) Communication between remote control and driver module breaks.
- 5) Connection between battery and driver module breaks.
- 6) Failure exists in the control system (e.g. motor is blocked or the low battery voltage level is detected).

10 Transport and Storage

Before long distance transport or long-term storage, please use ePropulsion original package to pack the pod drive.

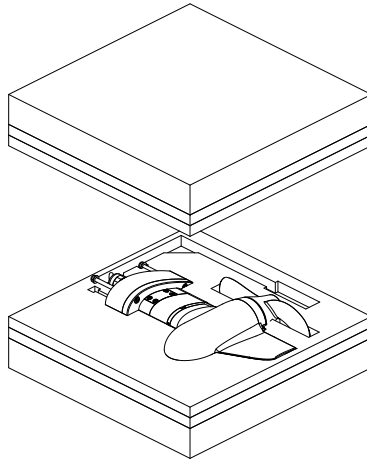



Figure 10-1

-  Make sure the pod drive gets adequate damping protection before transport and storage.
-  Store the pod drive in a well-ventilated and dry area without direct sun exposure.

11 Emergency Situations ---

11.1 Collision

If the pod strikes some object beneath the water, please follow below procedures.

1. Stop the pod immediately and then turn off the main switch.
2. Check the mechanical structure to see if there are damages.
3. Return to the nearest harbor or pier in low power.
4. Call your dealer to check the pod.

11.2 Low Battery Level

When the battery voltage is lower than 42V, the power will be limited by dropping voltage. When the battery voltage drops below 39V, the pod will stop automatically to prevent battery over-discharge. If this happens when the pod is far away from the shore, and there is an alternative battery, it's recommended to wait until the battery voltage rises 42V or above. When the voltage rises to a safe level, you can restart the pod system by restricting the power within 1000W.

11.3 Over-temperature Protection

The maximum input power of Pod Drive 3.0 has been limited to be below 3KW when the system temperature is high. If the system temperature continues to be warm and surpasses a threshold, the pod will shut down automatically to avoid over-temperature. Users should stop operating the pod and wait until the temperature falls within the normal operating temperature range.



12 Warranty

The ePropulsion limited warranty is provided for the first end purchaser of an ePropulsion product. Consumers are entitled to a free repair or replacement of defective parts or parts which do not conform with the sales contract. This warranty operates in addition to your statutory rights under your local consumer law.

12.1 Warranty Policies

ePropulsion warrants its products to be free of defects in material and workmanship for a limited period for non-commercial purposes since the date of purchase. Once a fault is discovered, the user has the right to make a warranty claim under the ePropulsion warranty policy.

Product	Warranty Expiration Date
Pod Drive 3.0	Two years after the date of purchase.
Repaired/Replaced Parts	Three months since the date of maintenance. Notes: 1. If the three-month period overlaps with the original warranty period, the warranty against these replaced or repaired parts still expires two years after the date of purchase. 2. If the three-month period exceeds the original warranty period, the warranty of the repaired or replaced parts expires by end of the third month since date of maintenance.

-  In order to validate the warranty, users are required to fill in the Warranty Card in the package in advance.
-  Keep the product label in an intact state and record the serial number on the label. Never tear the label off the product. An ePropulsion product without the original product label will not be applicable to warranty services provided by ePropulsion.
-  The warranty is valid only when the information is correct and complete.

 Free warranty is only validated upon the presentation of legal serial number, Warranty Card, and evidence of purchase from an authorized ePropulsion dealer.

 Valid date of purchase should be established by the first-hand purchaser with original sales slip.

 Free warranty is not transferable and will not be reissued.

12.2 Out of Warranty

Make sure the product is properly packed during delivery, the original ePropulsion package is recommended. If the product get further damage due to improper packing during delivery, the furtherly damaged part will be deemed as out of warranty coverage.

In addition, faults or damages caused by the following reasons are also excluded from warranty scope within the covered period:

- Any improper operation that contradicts the user manual.
- Accident, misuse, wishful abuse, physical damage overcharging or unauthorized repair.
- Dropping, improper care or storage.
- Used for commercial purposes.

 You should be noted that minor faults like normal wear and tear that pose no influence on the intended function of the product are also not covered by the warranty.

 Consumables are out of warranty scope.

12.3 Warranty Claim Procedures

If you find your product defective, you can make a claim to your dealer following below procedures:

1. Fill in Warranty Card correctly and completely in advance. Then make your warranty claim by sending it to your authorized ePropulsion service partner together with valid proof of purchase. Usually these documents are required when making a warranty claim: the Warranty Card, ex-factory serial number, and evidence of purchase.
2. Send the defective product to your authorized ePropulsion service point after getting the confirmation. Note that the label should be kept intact.

You can also deliver the product to your authorized ePropulsion dealer after getting confirmation.

3. The defective components or parts will be either repaired or replaced according to the diagnosis made by the ePropulsion authorized service partner.
 4. If your warranty claim is accepted, the equipment will be repaired or replaced free of charge. Note that any delivery cost incurred in the process is at your charge.
 5. After careful examination and confirmation by ePropulsion authorized dealer, the defective or faulty components will be repaired or replaced with brand new ones against the actual condition.
 6. In case your warranty claim be rejected, an estimated repair charge with round trip delivery cost will be sent for confirmation. ePropulsion authorized service point will conduct maintenance accordingly only after your confirmation.
-  If warranty expires, you can still enjoy maintenance services from authorized ePropulsion service partners with minimum maintenance charge.

Thanks for reading this user manual.

If you have any concerns or find any problems while reading, please don't hesitate to contact us. We are delighted to offer service for you.

Guangdong ePropulsion Technology Limited

Website: www.epropulsion.com

Email: service@epropulsion.com