

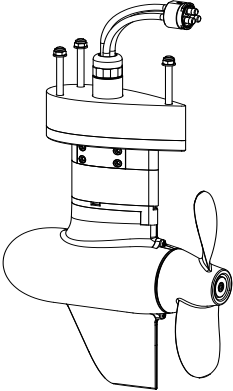

1 Product Overview

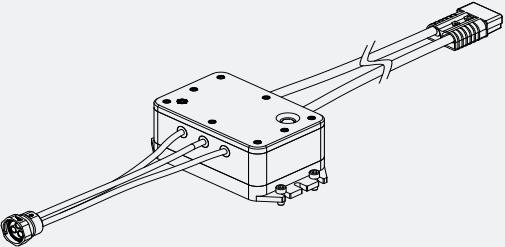

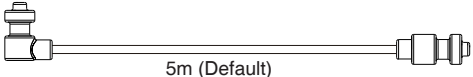
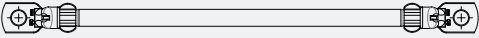
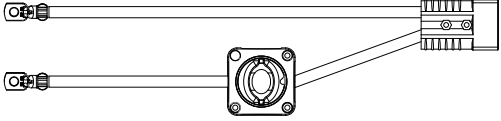

Pod Drive 3.0 is an electric pod drive system of 3kw input power, controlled by either NAVY Remote Control or Side Mount Control. Pod is gaining increasing population among boat owners in recent decades. But available premium electric pod systems are rare. Electric pod drives are environment-friendly, clean and very efficient. This 3kw electric pod drive system is equivalent of 6hp, perfect for recreational small and medium sized boats such as sailboats and some motor boats.

1.1 In the Package

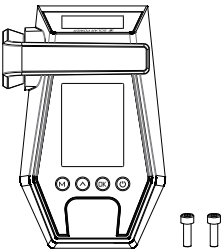
When you receive a set of Pod Drive 3.0, unpack its package and check if all the items below are included in the package. If there is any loss or transport damage, please contact your dealer immediately.

Items	Qty./Unit	Figure
Pod Motor	1 set	
Driver Module (w/ 4 x M8 screws)	1 set	

Items	Qty./Unit	Figure
Communication Cable	1 piece	 <p>5m (Default)</p>
Battery Bridging Cable	3 pieces	
Main Switch Cable	1 piece	
User Manual, Warranty Card, Invitation Card & Quality Certificate	1 set	
Remote Control (Purchased separately)	1 set	

-  The remote control need to be purchased separately.
-  Other accessories such as batteries, charger, etc. appearing in this manual but not included in this package list require users to purchase them from ePropulsion authorized dealers.
-  The propeller is installed on the pod in the package.
-  Save ePropulsion original package for transport and storage.

1.2 Parts and Diagrams

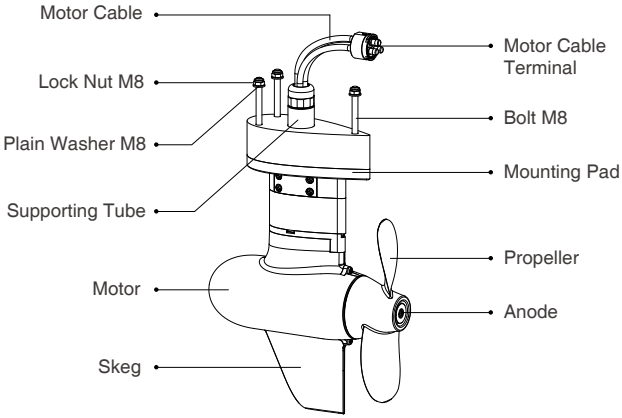

Figure 1-1 Motor Module

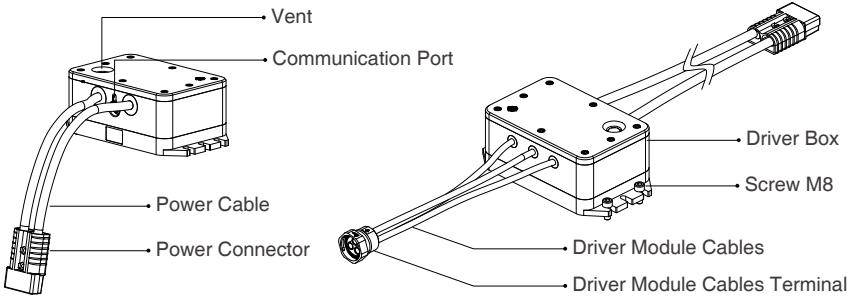

Figure 1-2 Driver Module

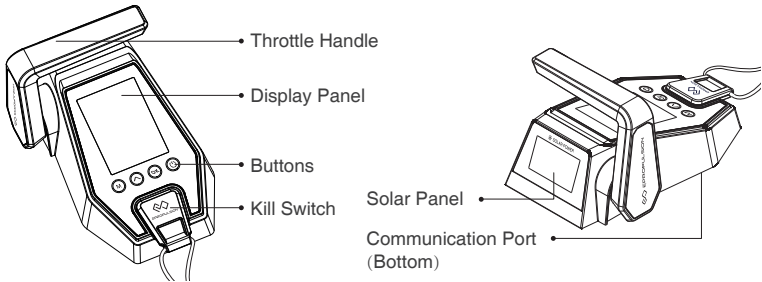

Figure 1-3 Remote Control (Purchased separately)